

PRODUCT DATA SHEET

Product Description: Towel ring, Sea Breeze. Post is fabricated from die cast zinc with a US15 satin nickel finish. Ring is fabricated from stainless steel with a US15 satin nickel finish. Ships with mounting hardware.

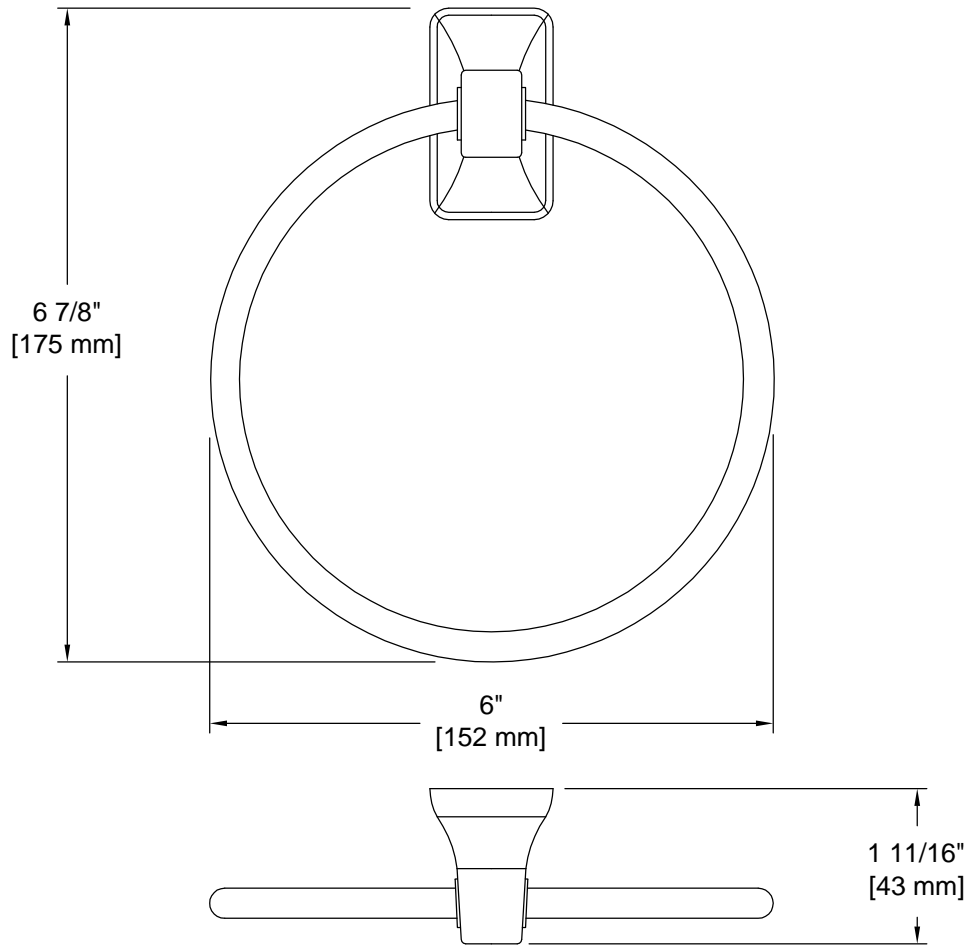

Overall Size: 6" W X 6 7/8" H X 1 11/16" D

Material: Zinc Post, Stainless Steel Ring

Finish: US15 Satin Nickel

Cross Reference

Manufacturer	Part Number



Description:

Towel Ring, Sea Breeze

Part Number:

12030

Date

06/10

Rev.

01